

Article number: 604145032040

Description: Timing belt pulley with hub
HTD 32 14M 40

Measures

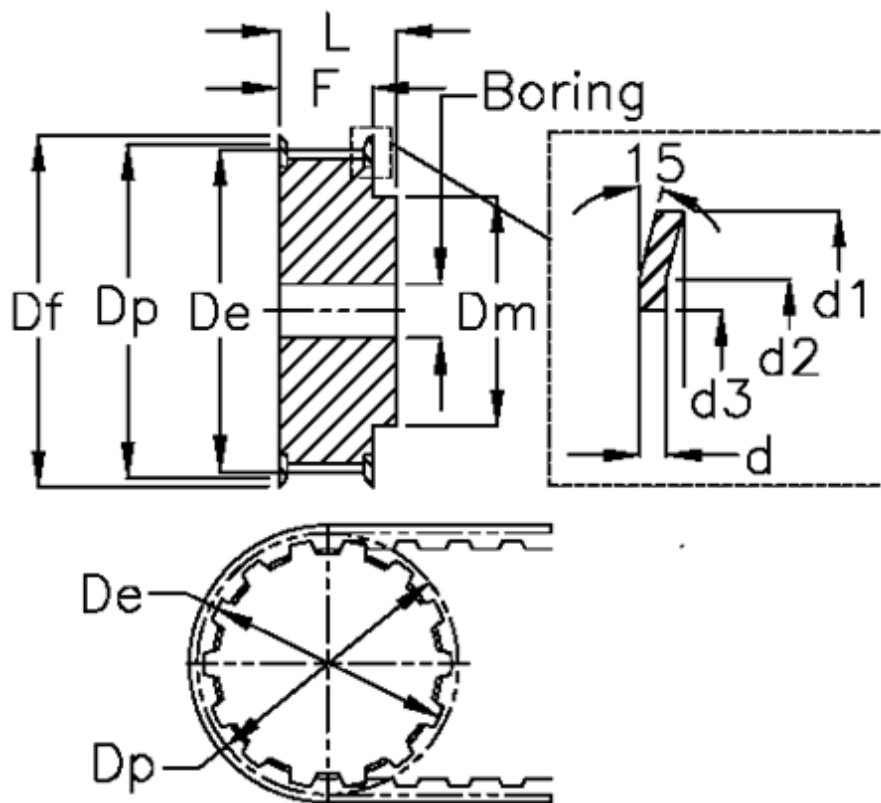

Bore = 24	Dp	= 142.6
d = 2.5	F	= 54
d1 = 154	Flange type	= F49
d2 = 142	L	= 69
d3 = 122	Tooth number	= 32
De = 139.88	Type	= 14M
Df = 154	Weight	= 6.17
Dm = 100	Width	= 40